

OBSERVAÇÕES

- 1 - AS CAIXAS D'ÁGUA DEVERÃO TER O FUNDO APOIADO EM SUPERFÍCIE PLANA;
 - 2 - AS REDES DE ÁGUA FRIA DEVERÃO SER MONTADAS COM DECLIVIDADES MÍNIMAS DE 0,5% DE FORMA QUE:
 - O AR PORVENTURA EXISTENTE NA REDE SEJA ELIMINADO NA CAIXA D'ÁGUA
 - TUBOS CAINDO 0,5% DA CAIXA D'ÁGUA EM DIREÇÃO AS FUNDAMENTOS;
 - 3 -USAR REGISTRO GAVETA EM CADA AF A UMA ALTURA DE 2,00M.
 - 4) NO CASO DE DÚVIDA ENTRE ESCALA E COTA PREVALECEM AS COTAS.
- DECLIVIDADES DOS TUBOS DE ATURAS DOS PONTOS DE ESCOTO:
- MICROIO - 0,60 m
 - PIA DE COZINHA - 0,60 m
 - PIA DE CHUFRASQUEIRA - 0,60 m
 - TANQUE DE LAVAR ROUPAS - 0,60 m
 - MACHINA DE LAVAR ROUPAS - 0,60 m
 - P / TUBOS AÉREOS - $i \geq 1,00\%$
 - $\phi \geq 150 \text{ mm} - i \geq 1,00\%$
- OBS.: - ATURAS MEDIDAS DOS EIXOS DOS PONTOS AO ISO ACABADO

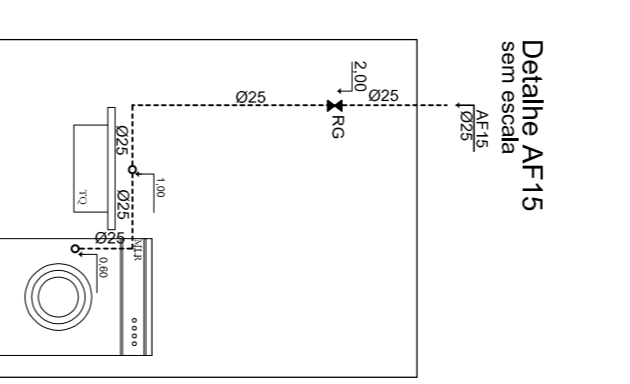

TANQUE SEPTICO (V=1000L=1M ³ x 1,1)		FILTRO ANAEROBIO (V=1000L=1M ³ x 1,1)	
CONT. (L)	DIAM. (mm)	CONT. (L)	DIAM. (mm)
2000	1000	2000	1000
1500	750	1500	750
1000	500	1000	500
500	250	500	250

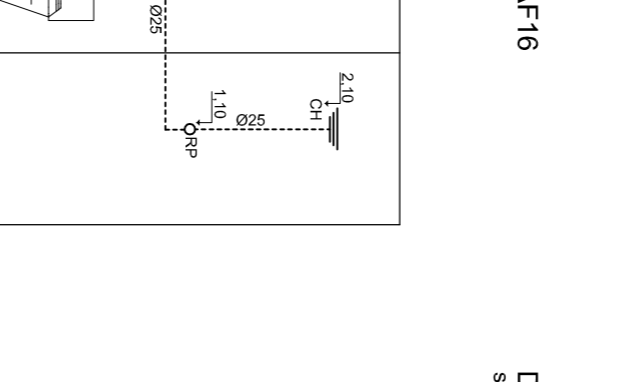
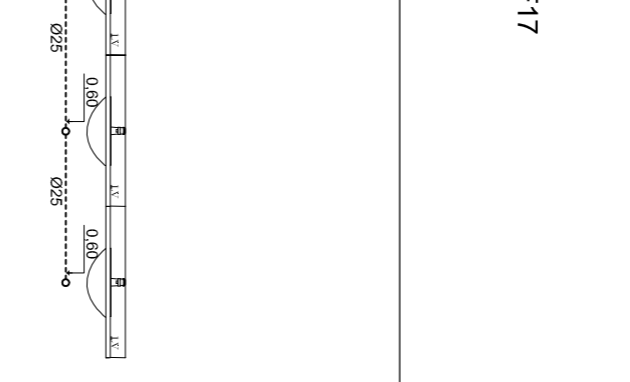
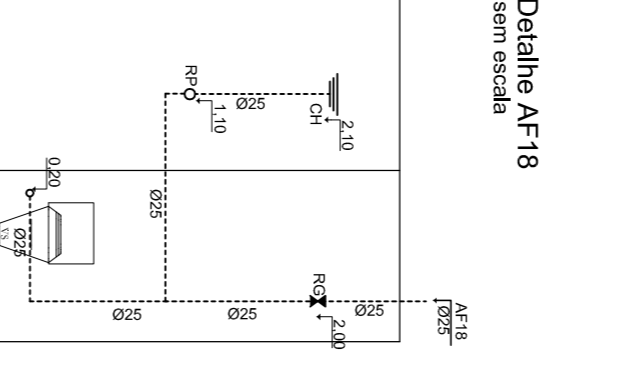
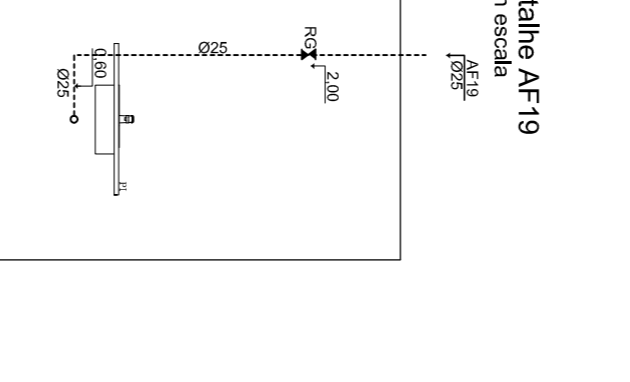
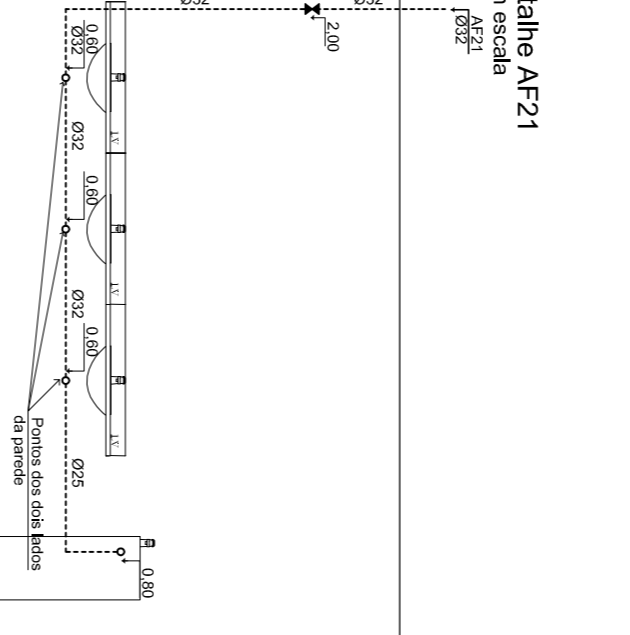
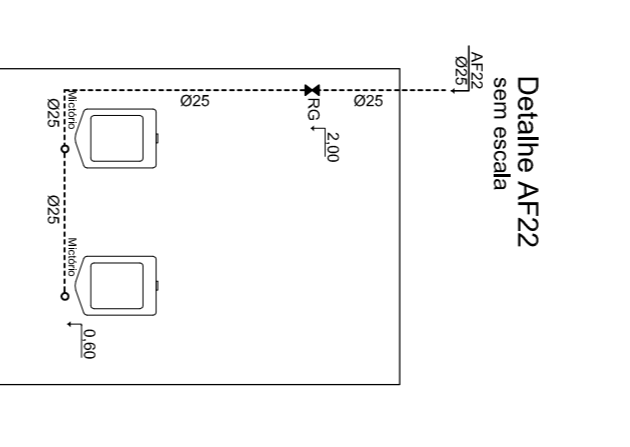
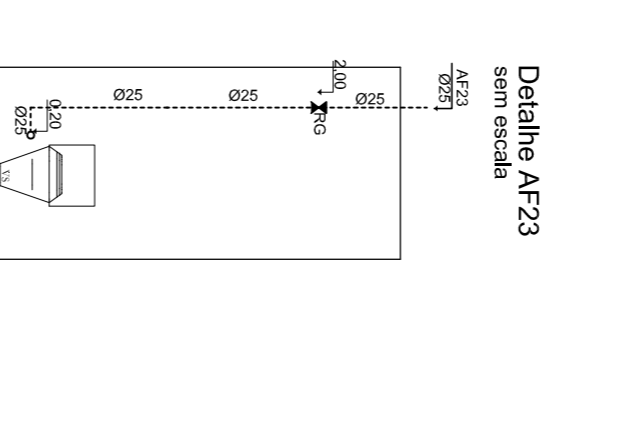
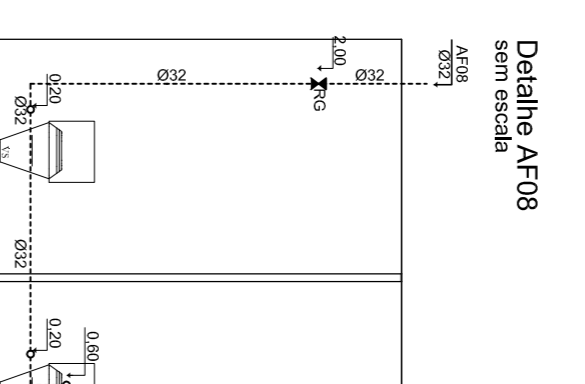
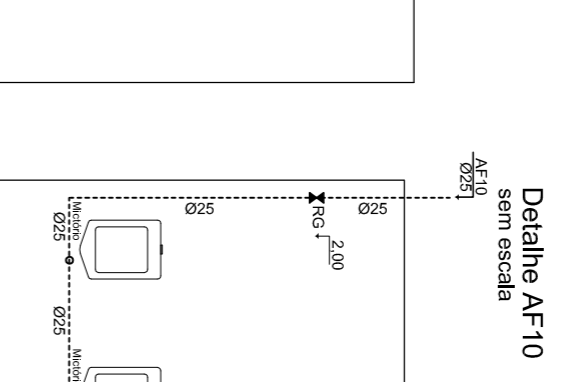
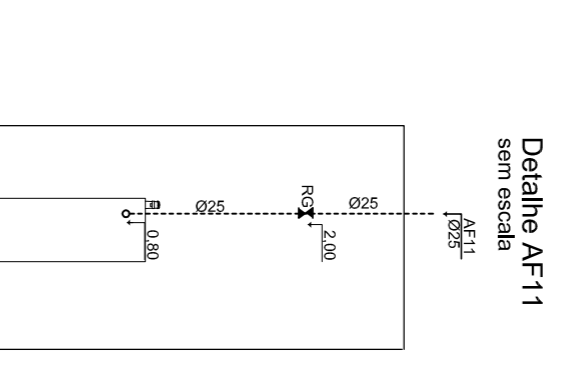
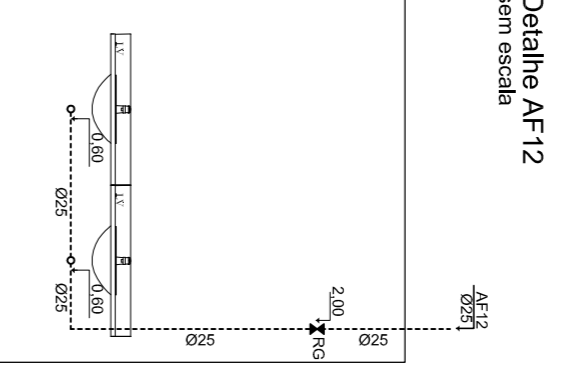
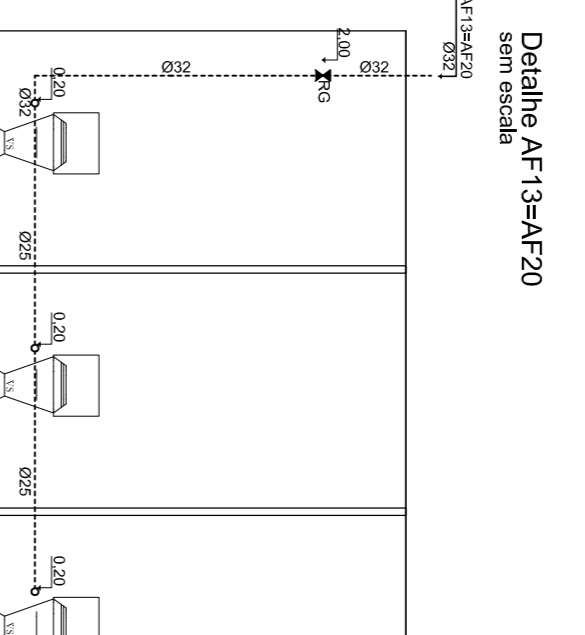
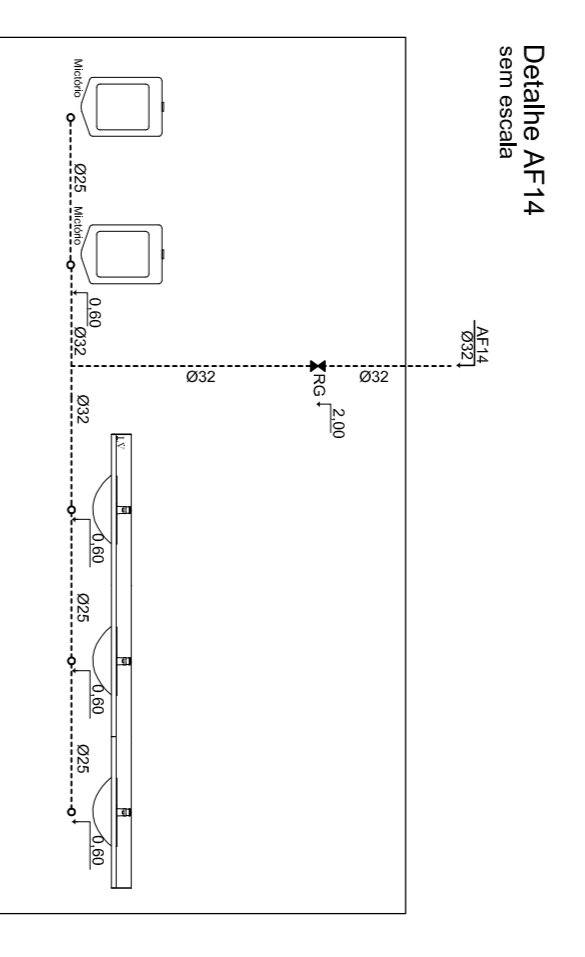
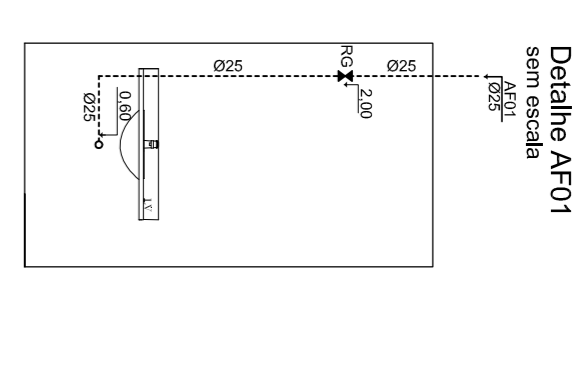
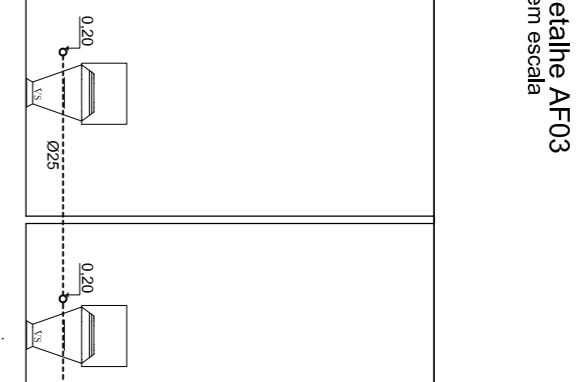
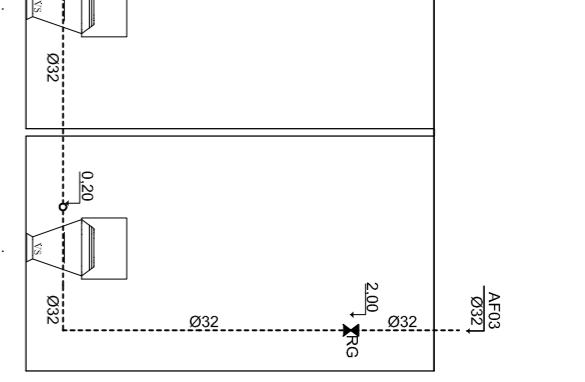
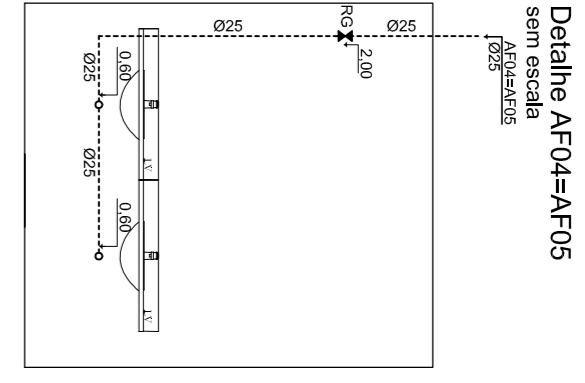
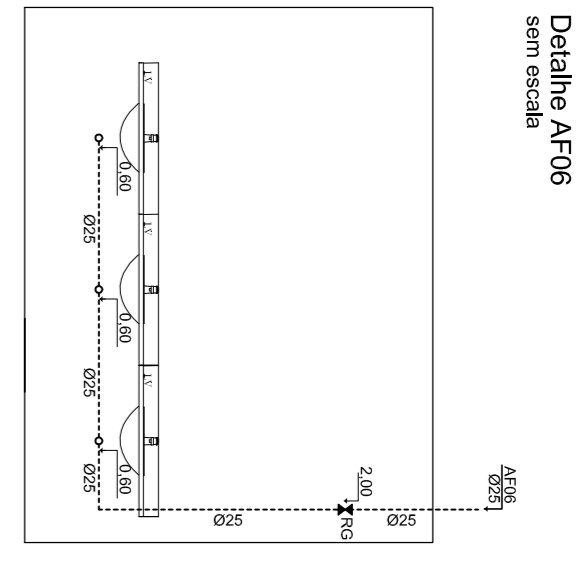
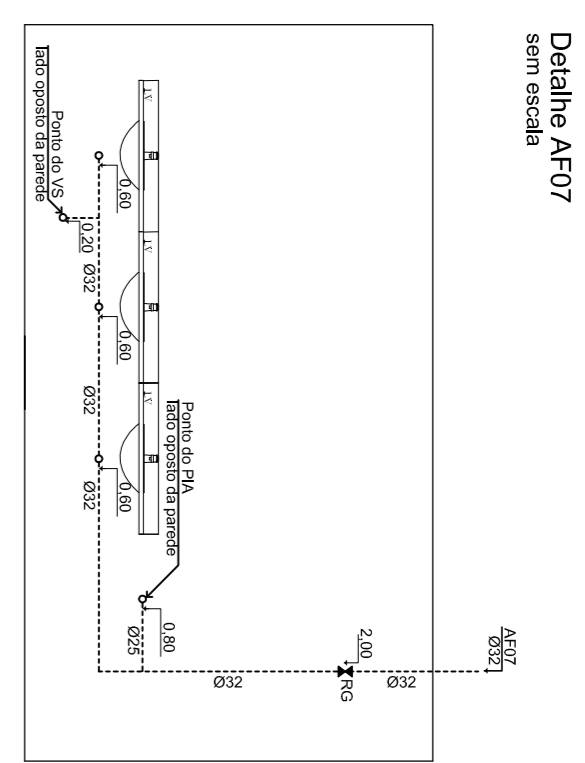
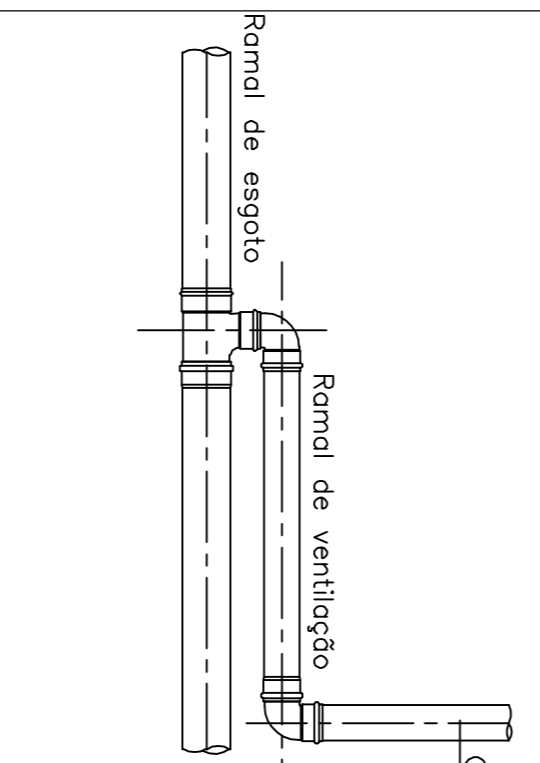
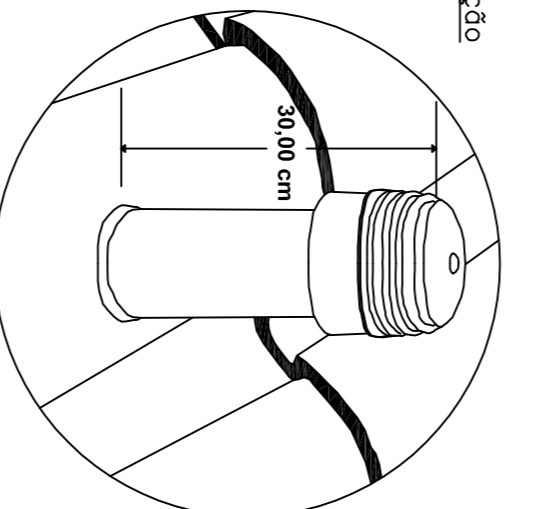

DETALHE ESCOVA DE LIGAÇÃO DO RANHAL E COLUMNA DE VENTILAÇÃO

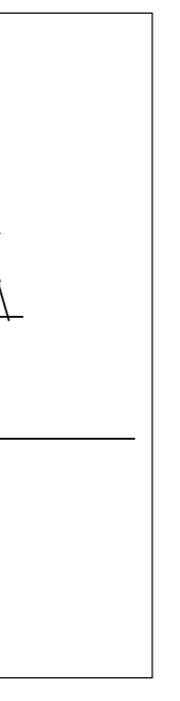
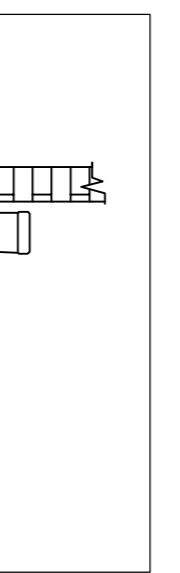

DETALHE ESCOVA DE LIGAÇÃO DO RANHAL E COLUMNA DE VENTILAÇÃO

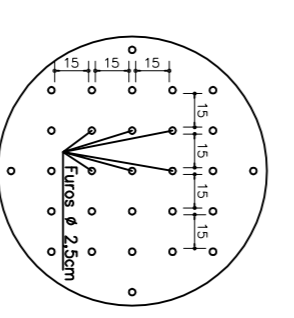

DET. DO FUNDO FALSO

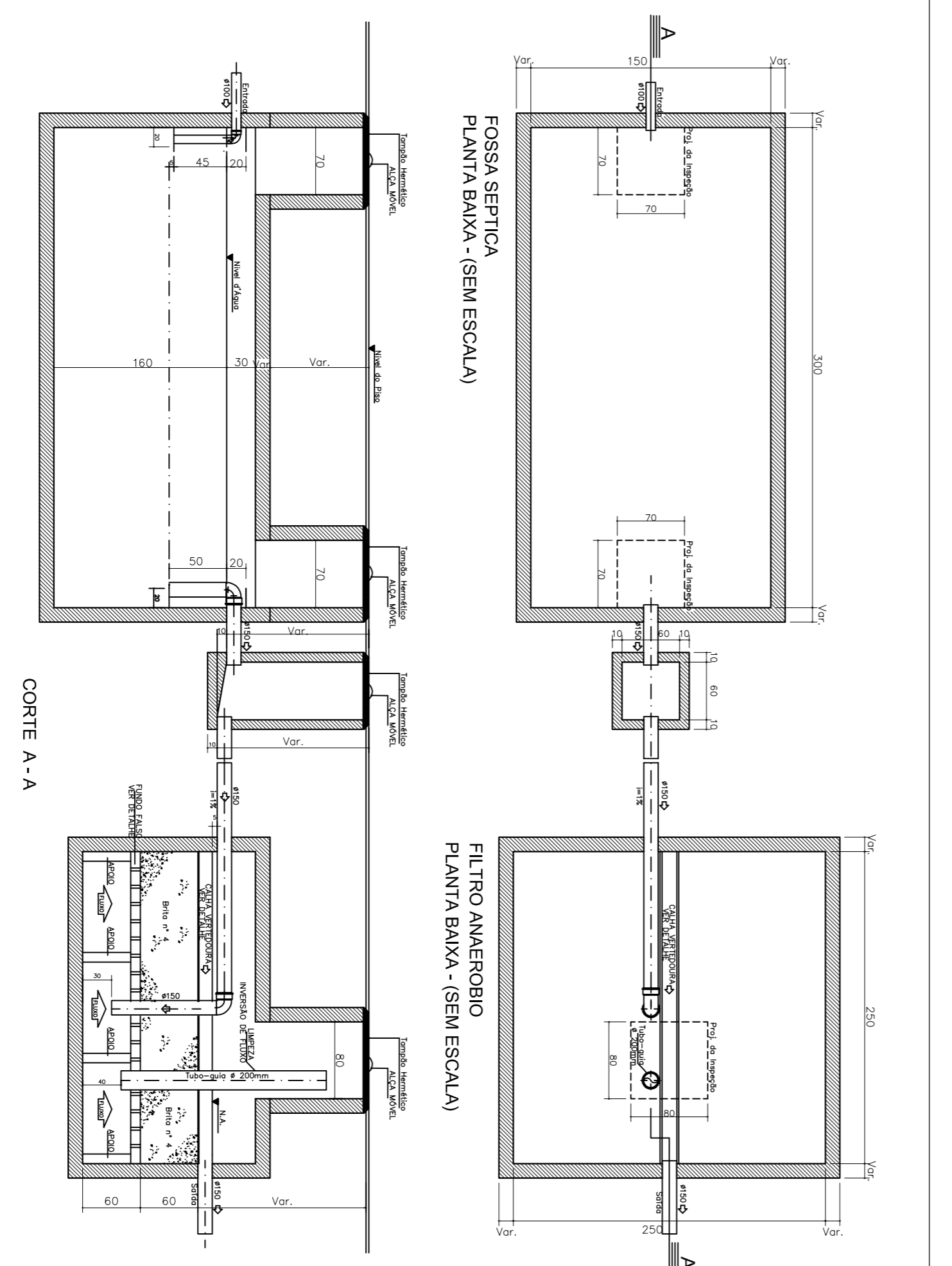

CORTE A-A-A

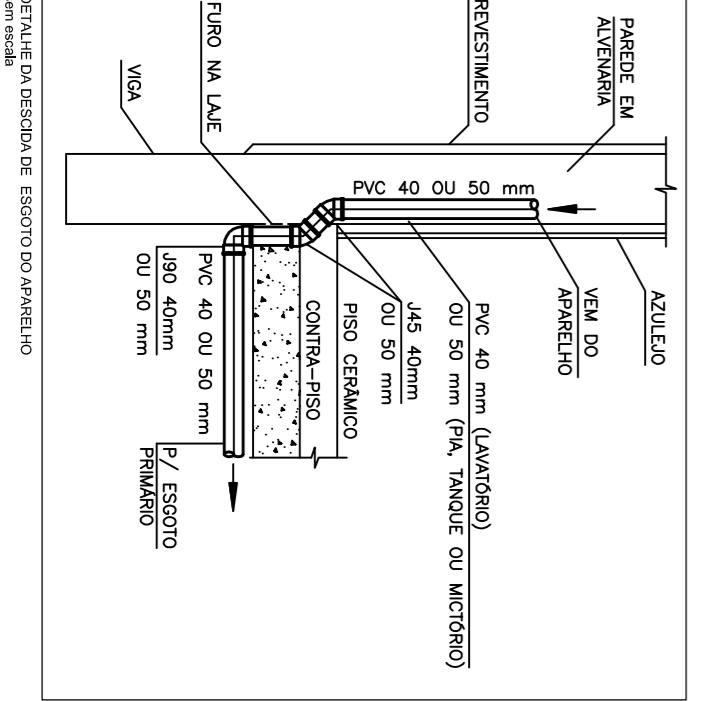
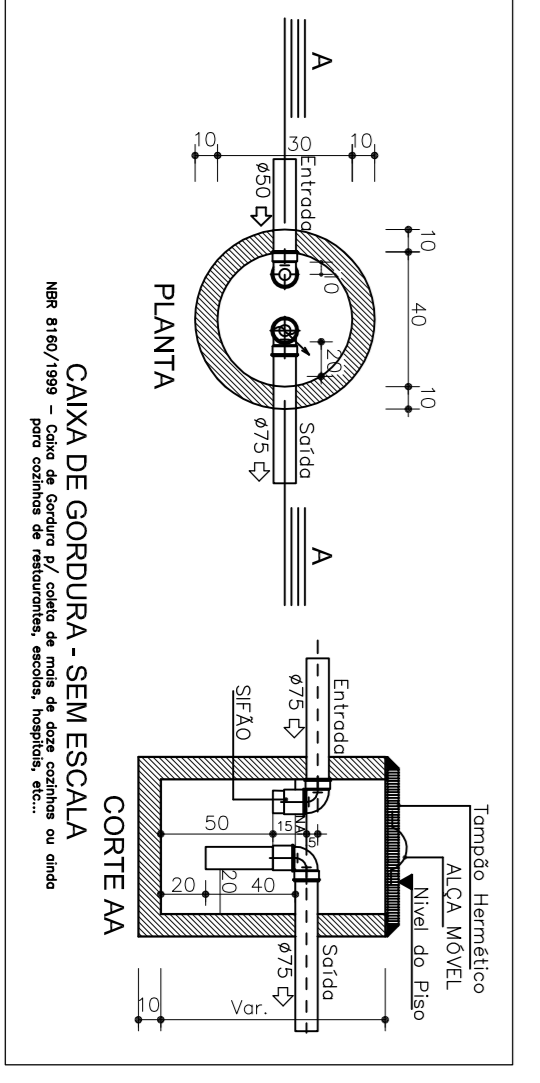
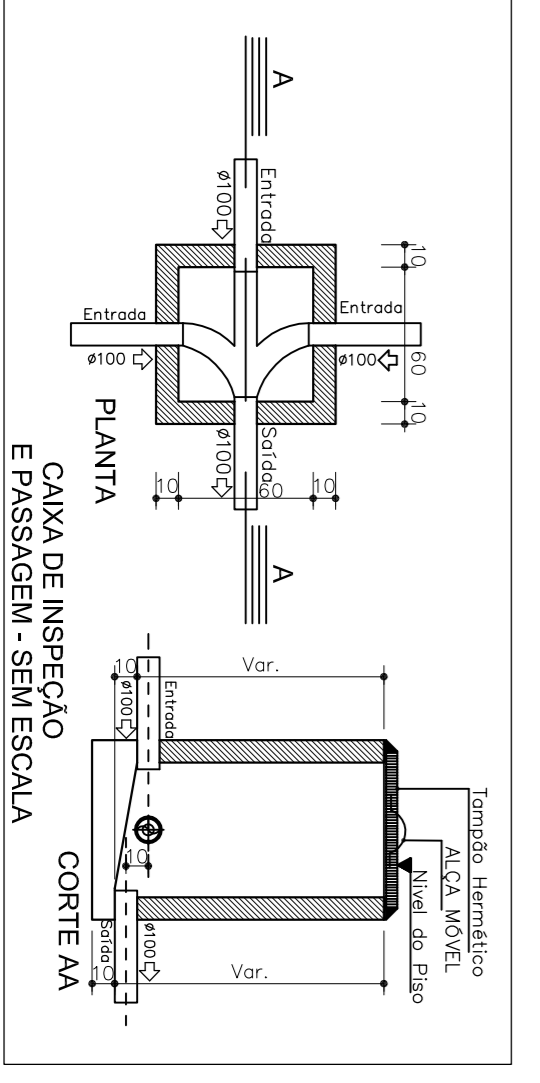

PROJETO HIDROSSANITÁRIO

ASSOCIACAO DOS MATEIRIS DO ALTOVALE DOITUAL

AV. XV DE NOVEMBRO, N° 777
 FONE/FAX: (41) 3531422
 CEP: 81800-000 CENTRO
 Curitiba - PR
 E-mail: amavi@amavipr.org.br

OBRA: CONSTRUÇÃO DA PREFEITURA E CAMARA MUNICIPAL DE BRAÇO DO TROMBUDO
 PROJETANTE: PREFEITURA MUNICIPAL DE BRAÇO DO TROMBUDO
 ENGENHEIRO: RUIA TIRADENTES - CENTRO - BRAÇO DO TROMBUDO / SC

CONTEUDO:
 VISTAS ÁGUA FRIA
 DETALHE FOSSA SEPTICA E FILTRO ANAEROBIO
 DETALHE CAIXA DE GORDURA E INSPEÇÃO

ESCALA: INDICADA
 DATA: 19/12/2011
 AREA TOTAL: 1563,74 m²
 DISSENHO: ANIEL MESSON
 EXECUÇÃO - RESPONSÁVEL TÉCNICO:

PRIMEIRO PLANO: SAN. 05/05

TODOS OS DIREITOS RESERVADOS
 Proibida a reprodução parcial ou total
 por qualquer meio. Todos os direitos reservados à autora.